

CLAMPOR®

air



MULTI-SANDER KIT

MODEL NO: CAT176

PART NO: 3120193

OPERATING & MAINTENANCE INSTRUCTIONS

UK
PA | CE

ORIGINAL INSTRUCTIONS

DL0522 - ISS 2

INTRODUCTION





Thank you for purchasing this CLARKE Air Tool Kit.

Before attempting to use this product please read this manual thoroughly and follow the instructions carefully. In doing so you will ensure the safety of yourself and that of others around you, and you can look forward to your purchase giving you long and satisfactory service.

Your tool kit has been designed to give long and trouble free service. If, however, having followed the instructions in this booklet carefully, you encounter problems, take the unit to your local CLARKE dealer.

SAFETY SYMBOLS

The following safety symbols are to be found on the air tool.

	Read this instruction booklet carefully before use.		Wear ear protection.
	Wear eye protection.		Wear dust mask.

GUARANTEE

This product is guaranteed against faulty manufacture for a period of 12 months from the date of purchase. Please keep your receipt which will be required as proof of purchase.

This guarantee is invalid if the product is found to have been abused or tampered with in any way, or not used for the purpose for which it was intended. Faulty goods should be returned to their place of purchase, no product can be returned to us without prior permission. This guarantee does not effect your statutory rights.

GENERAL SAFETY RULES



CAUTION: FAILURE TO FOLLOW THESE PRECAUTIONS COULD RESULT IN PERSONAL INJURY, AND/OR DAMAGE TO PROPERTY.

WORK ENVIRONMENT

1. Keep the work area clean and tidy.
2. Dress appropriately - Do not wear loose clothing or jewellery. Tie long hair out of the way.
3. Keep children and visitors away - Do not let children handle the tool.
4. Do not use the tool where there are flammable liquids or gases.

PERSONAL SAFETY

1. Stay alert and use common sense - do not operate the air tool when you are tired or under the influence of alcohol, drugs or medication.
2. Always wear eye protectors when using the tool. Eye protectors must provide protection from flying particles from the front and the side.
3. Always wear ear protectors when using the air tool.
4. Always wear a dust mask when operating this type of tool.
5. Do not overreach - Keep proper footing and balance at all times.
6. Ensure wrenches are disconnected from the air tool before turning it on. A wrench left attached to a rotating part of the tool may result in personal injury.

USE OF AIR POWERED TOOLS

1. Never use oxygen, CO₂, combustible gases or any type of bottled gas as a source of power for the tool.
2. Do not connect the air supply hose with your finger on the trigger.
3. Do not exceed the maximum pressure for the tool of 90 psi / 6.2 bar.
4. Check hoses for leaks or worn condition before use and ensure that all connections are secure.
5. Do not use the tool for any other purpose than that described in this manual.
6. Keep the air supply hose away from heat, oil and sharp edges.

7. Do not fit the tool to any stand or clamping device that may damage it.
8. Do not carry out any alterations or modifications to the tool.
9. Always disconnect from the air supply when:
 - Performing any maintenance.
 - The tool is not in use.
 - The tool will be left unattended.
 - Moving to another work area.
 - Passing the tool to another person.
10. Never use the tool if it is defective or operating abnormally.
11. The tool should be serviced at regular intervals by qualified service personnel.
12. Avoid damaging the tool by applying excessive force of any kind.
13. Always maintain the tool with care. Keep it clean for the best and safest performance.
14. Quick change couplings should not be located at the tool. They add weight and could fail due to vibration.
15. Do not force or misuse the tool. It will do a better and safer job at the rate for which it was designed.
16. Do not remove any labels. Damaged labels should be replaced.
17. This tool vibrates with use. Vibration may be harmful to your hands or arms. Stop using the tool if discomfort, a tingling feeling or pain occurs. Seek medical advice before resuming use.

USE OF THE GRINDING TOOLS

1. Try to hold the tool with both hands. Ensure that the workpiece is kept at waist height where possible. Never use the tool between the legs whilst sitting on the floor.
2. Ensure that sparks and particles resulting from use do not create a hazard. Use screens where appropriate.
3. Never bump the grinding stones onto the workpiece, or let it hit any other objects while grinding.
4. Always allow the tool to run up to full operating speed before applying it to the job.
5. Use clamps, or vices to hold the workpiece. Failure to secure the workpiece could result in personal injury.

USE OF THE SANDING DISCS

1. Inspect any sanding disc before use. Do not use if split or broken.
2. Avoid contact with the moving sanding disc and wear gloves to protect the hands.
3. Never run the tool unless the abrasive pad is applied to the workpiece.
4. Beware of potentially explosive atmospheres being caused by dust / fumes resulting from sanding and used dust extraction systems where possible.
5. Always wear a face mask when using the sander as protection from airbourne particles of sanded material. Avoid disturbing existing dust and minimise the scattering of dust in the worplace environment. Take steps to control the dust at the point of emission.

TRANSPORTATION AND STORAGE

1. Never carry the tool by the air supply hose or with your finger on the trigger.
2. When not in use the tool should be disconnected from the air supply and stored in a dry place out of the reach of children.
3. Avoid storing the tool in environments where the temperature is below 0°C.

SPECIFICATIONS

Model Number	CAT176
Dimensions (L x W x H)	155 x 38 x 74 mm
Weight (tool only)	0.7 kg
Air Inlet Size	1/4" BSP (female)
Operating Pressure	90 psi (6.2 bar)
Measured Air Consumption	12 cfm maximum
No Load Speed	17,000 rpm @ 90psi
Sound Pressure Level (LpA dB)	88 dB(A)
Sound Power Level (LwA dB)	99 dB(A)
Vibration Levels	<2.9 m/s ²

Please note that the details and specifications contained here are correct at the time of going to print. However CLARKE International reserve the right to change specifications at any time without prior notice.

CONTENTS OF THE KIT

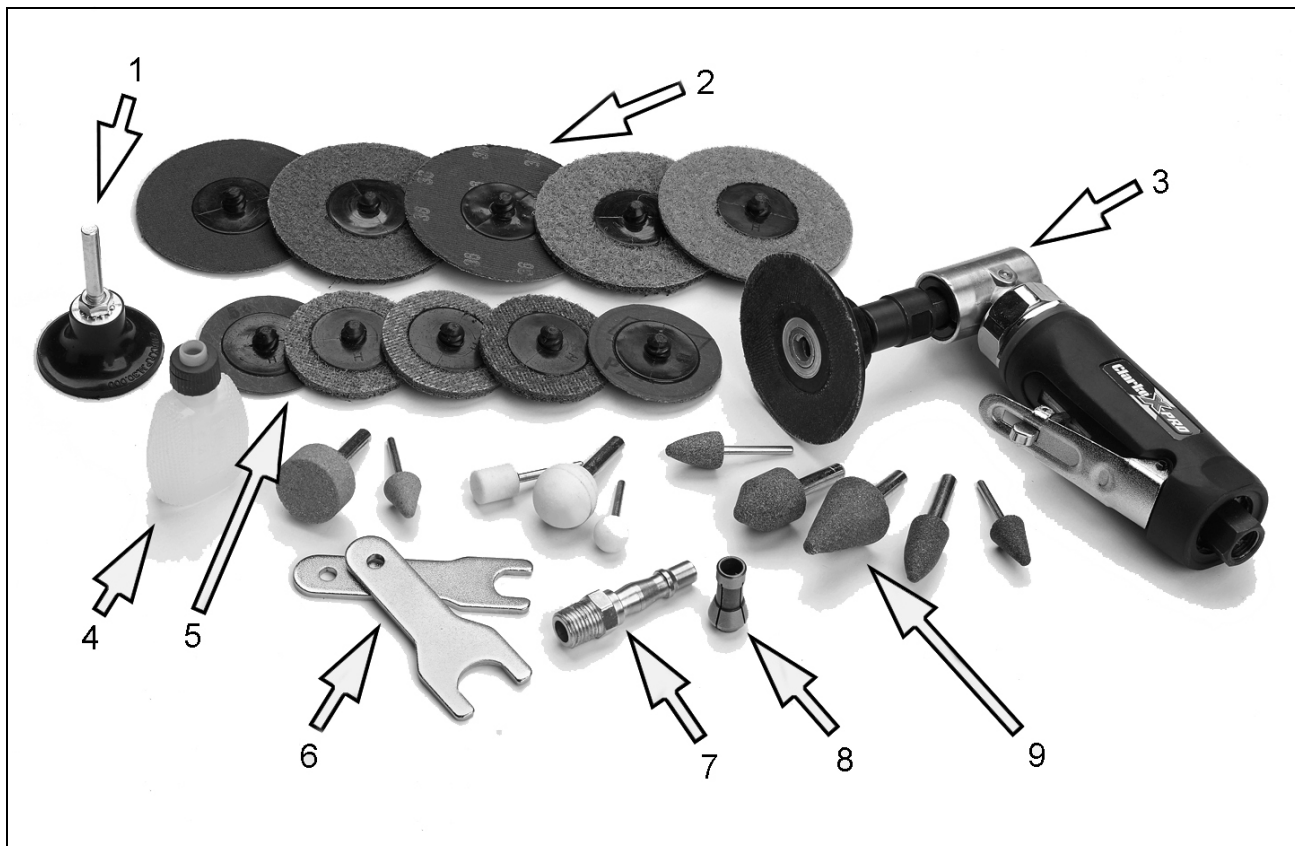

NO	DESCRIPTION	NO	DESCRIPTION
1	Sanding Arbor	6	2 x Wrenches (11 and 17 mm)
2	5 x 75 mm Sanding Pads	7	1 x Male Snap Connector
3	CAT176 Air Tool	8	2 x Collets (1 already fitted to tool)
4	Oil Bottle	9	10 x Grinding Stones
5	5 x 50 mm Sanding Pads		

When opening the case for the first time, check that all items are present. Any damage or deficiency should be reported to your CLARKE dealer immediately.

COMPRESSED AIR REQUIREMENTS



WARNING: COMPRESSED AIR CAN BE DANGEROUS. ENSURE THAT YOU ARE FAMILIAR WITH ALL PRECAUTIONS RELATING TO THE USE OF AIR COMPRESSORS AND COMPRESSED AIR SUPPLIES.

- Use only clean, dry, regulated compressed air as a power source.
- Air compressors used to drive this tool must comply with the appropriate European Community Safety Directives.
- A build-up of moisture or oil in the air compressor will accelerate wear and corrosion in the tool. Ensure any moisture is drained from the compressor daily and the inlet filter is kept clean.
- If an unusually long air hose is required, (over 8 metres), the line pressure or the hose inside diameter may need to be increased.
- The air hose must be rated at least 150% of the maximum operating pressure of the tool.

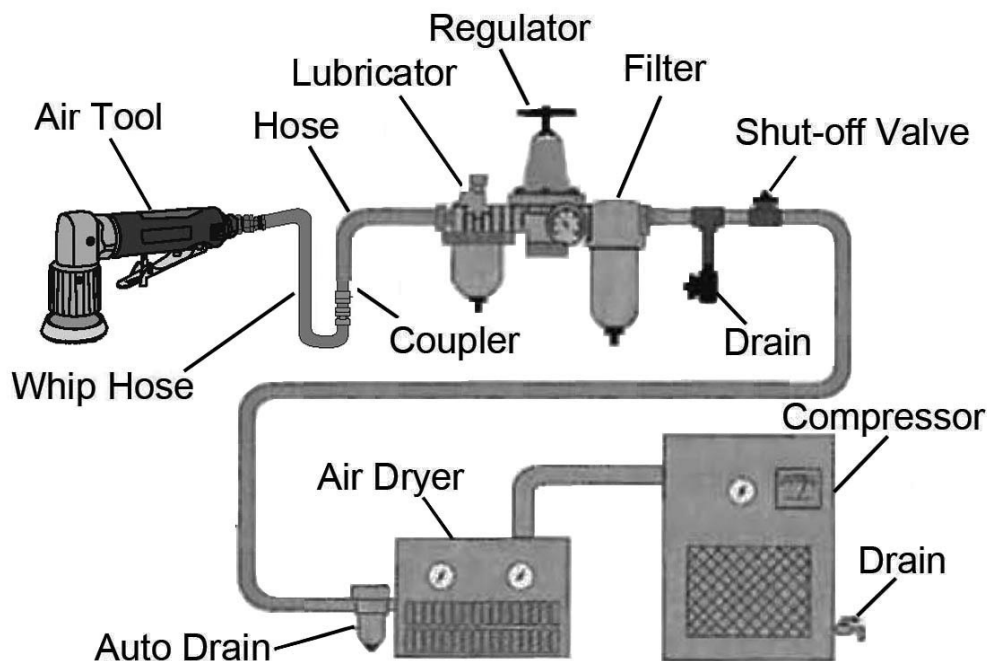

- A typical air line layout is shown above. If an automatic in-line filter/regulator is used, it will keep the tool in good condition, but should be regularly checked and topped up with oil. SAE 10 oil should be used and the lubricator adjusted to approx 2 drops per minute.
- Never exceed the maximum operating pressure for the tool. It is recommended that air pressure does not exceed 90 psi when running. Higher pressures and contaminated air will shorten the life of the tool due to faster wear and is a possible safety hazard.

BEFORE USE



WARNING: COMPRESSED AIR CAN BE DANGEROUS. ENSURE THAT YOU ARE FAMILIAR WITH ALL PRECAUTIONS RELATING TO THE USE OF AIR COMPRESSORS AND COMPRESSED AIR SUPPLIES.

CONNECTING AIR HOSES

NOTE: Ensure the compressor is turned off while connecting hoses.

1. If required, connect an in-line lubricator to the tool.
 - A lubricator helps to prolong the life of the air tool.
2. If a lubricator is not being used, run a few drops of oil through the tool before use. It can be entered through the air inlet or via the hose at the nearest connection to the air supply.
3. Connect a suitable hose to the air inlet as shown.
4. Connect the other end of the hose to the compressor.

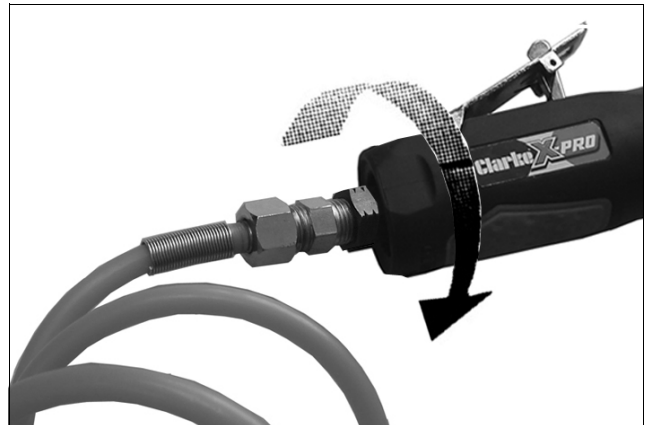

Your air tool is now ready for use.

You can fit a whip hose with a quick fit coupling if required (available from your Clarke dealer).

INSTALLING THE COLLET

1. Select the grinding stone you require.
2. Two collets of different sizes are provided. Select whichever fits the shank of the stone you have chosen.
 - One collet may already be installed in the grinder.
3. If the other collet is to be used, undo the retaining collar completely and pull out the collet from the collet seat. Replace it with the new collet and screw the collar loosely back on.

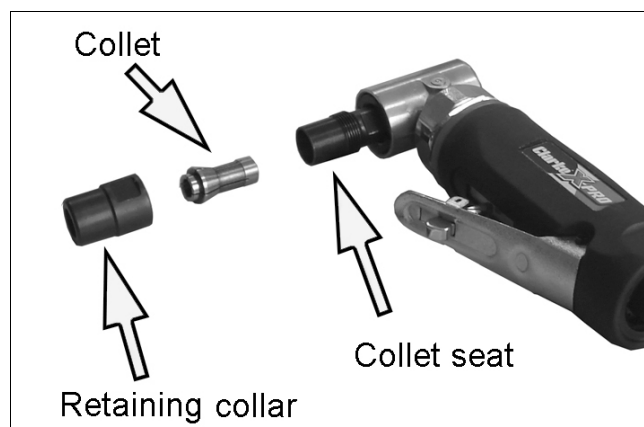

FITTING THE GRINDING STONE

IMPORTANT: Never use chipped or cracked grindstones.

1. Slip the shank of the chosen stone into the collet and tighten the retaining collar finger tight.
2. Place the smaller of the two wrenches over the collet seat to stop the tool from rotating.
3. Use the larger wrench to fully tighten the collet and grip the stone in position as shown.

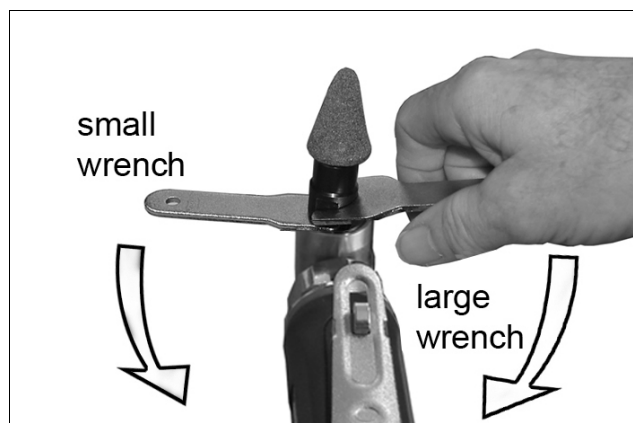

FITTING THE SANDING DISC

1. Fit the larger collet to the tool and slip the spindle into the collet. Secure in place by tightening the collar as above.
2. Screw the sanding arbor onto the spindle and secure by tightening the nut against it using the larger wrench.
3. Screw the sanding pad onto the sanding arbor.

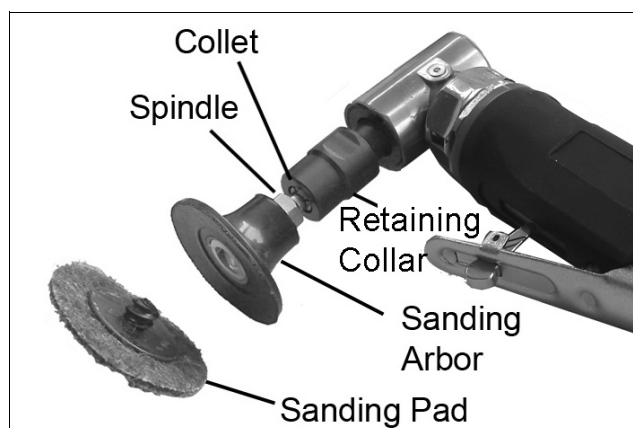

OPERATING THE TOOL

1. Use your thumb to slide the throttle locking lever forward while squeezing the trigger against the body of the tool.
2. Adjust the tool speed by varying the pressure on the trigger.
3. Do not use excess pressure on the grinding stone as this will shorten its life.
4. Release the trigger to stop the tool.
 - The tool will continue to rotate for a short time after the trigger has been released.
5. Always ensure the tool has stopped before putting it down.

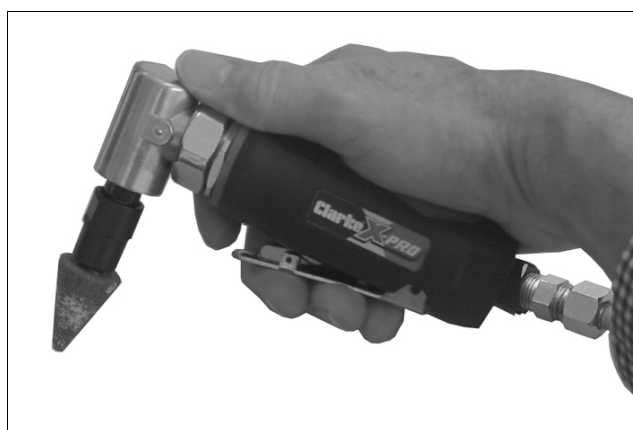

SANDING AND GRINDING TIPS

- Do not force the disc or stone against the material.
- The key to efficient grinding is to control the pressure and surface contact between the grinding tool and the workpiece.
- Allow the tool to reach full speed before grinding.
- Avoid overloading the grinder. If it becomes hot during use, rest for a few minutes while it cools down.

TROUBLESHOOTING

SYMPTOM	PROBLEM	SOLUTION
Tool runs at normal speed but slows down under any load.	<ol style="list-style-type: none"> 1. Excessive pressure on tool. 2. Motor parts worn. 3. Worn or sticking mechanism due to lack of lubricant. 	<ol style="list-style-type: none"> 1. Reduce the force applied to the tool. 2. Return to Clarke dealer for repair. 3. Drip air tool lubricating oil into the air inlet. Allow oil to soak the moving parts before using.
Tool runs slowly. Air flows weakly from exhaust.	<ol style="list-style-type: none"> 1. Motor parts jammed with gum/dirt. 2. Regulator in closed position. 3. General airflow blocked by dirt. 	<ol style="list-style-type: none"> 1. Examine inlet air filter for cleanliness. 2. Adjust the regulator to the open position. 3. Operate the tool in short bursts.
Tool will not run. Air flows freely from exhaust.	<ol style="list-style-type: none"> 1. Motor vanes stuck due to buildup of foreign material. 	<ol style="list-style-type: none"> 1. Disconnect air supply and rotate tool assembly manually. 2. Try operating tool in short bursts. 3. Drip a few drops of air tool lubricating oil into the air inlet to soak moving parts.
Tool will not shut off.	<ol style="list-style-type: none"> 1. Throttle O-rings damaged or ill-fitting in seat. 	<ol style="list-style-type: none"> 1. Return to Clarke dealer for repair.

DISCONNECTING THE AIR SUPPLY

1. Do not disconnect the air supply hose until the compressor has been shut down and the compressed air released.
2. Refer to the compressor instruction manual for the procedure to shut down and release the compressed air.
3. Once the pressure has been released, disconnect the air supply hose from the air tool.

MAINTENANCE



WARNING: MAKE SURE THAT THE AIR TOOL IS DISCONNECTED FROM THE AIR SUPPLY BEFORE STARTING ANY CLEANING OR MAINTENANCE PROCEDURES.

DAILY

1. Before use, drain water from the air tank, air line and compressor.
2. Pour a few drops of CLARKE airline oil into the air inlet. This should be carried out regardless of whether or not an in-line mini oiler is used. If an in-line lubricator is not used, this procedure should be repeated after every two to three hours of use.

WEEKLY

1. Check the air inlet strainer for blockage and clean if necessary.

CLEANING

1. Keep the body of each tool clean and free from debris.
2. Grit or gum deposits inside the tool may also reduce its efficiency. This condition can be corrected by cleaning out the air strainer and flushing out the tool with gum solvent or oil, or failing this, the motor may require dismantling. This is better left to your Clarke dealer.

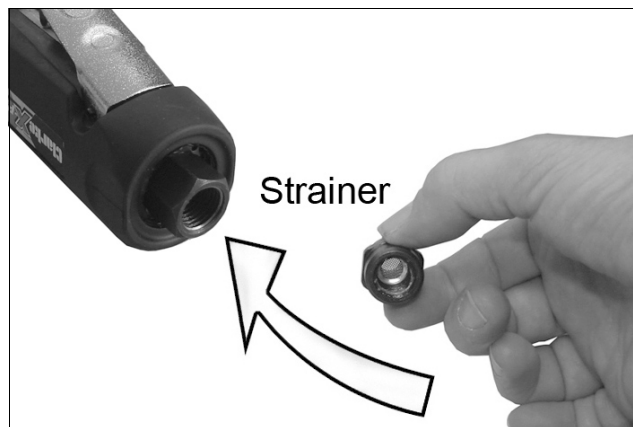

GREASING

The right angle drive is fitted with a grease nipple to provide a facility for lubrication of the drive gears.

1. After extensive use, apply a shot of general purpose grease using a suitable grease gun.

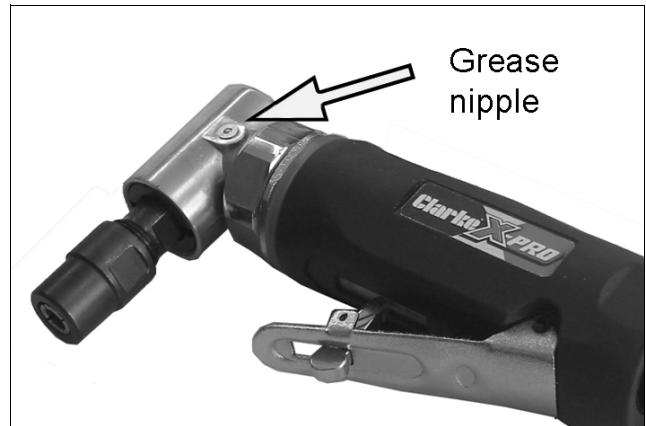

SERVICE AND REPAIR

If the tool runs erratically or becomes inefficient although the air supply is in good order, it may be necessary to dismantle the air motor and replace any worn or damaged parts. Such servicing and repair work should be carried out by a qualified service technician.

PERFORMANCE

Please note that factors outside the tool may effect its operation and efficiency such as reduced compressor output, excessive air demand from the airline, moisture or restrictions in the air-line, or the use of connectors of improper size or poor condition which will reduce air supply.

**Clarke Air Line Oil (part no. 3050825) is available from your CLARKE dealer.

STORAGE

If the tool is to be stored, or is idle for longer than 24 hours, run a few drops of Clarke air line oil into the air inlet, and run the tool for 5 seconds in order to lubricate the internal parts.

When not in use, disconnect from air supply, clean tools and store in the moulded case provided. When storing, ensure the blanking plug is replaced on the airline connector once the airline is disconnected.

ACCESSORIES

A wide range of accessories is available including filter/regulators, lubricators, high-pressure hoses (5 to 50 metres) etc. Contact your CLARKE dealer for further information or CLARKE International Service Department.

DECLARATION OF CONFORMITY



Hemmill Street, Eppring, Essex CM16 4LG

DECLARATION OF CONFORMITY

This is an important document and should be retained.

We hereby declare that this product(s) complies with the following statutory requirement(s):

Supply of Machinery (Safety) Regulations 2008

The following standards have been applied to the product(s):

EN/ISO 11148-9:2011

The technical documentation required to demonstrate that the product(s) meet(s) the requirement(s) of the aforementioned legislation has been compiled and is available for inspection by the relevant enforcement authorities.

The UKCA mark was first applied in: 2022

Product Description: X-Pro Multi Sender Kit
Model number(s): CAT176
Serial / batch Number: N/A
Date of Issue: 24/05/2022

Signed:

J.A. Clarke
Director



Fitzwilliam Hall, Fitzwilliam Place, Dublin 2

DECLARATION OF CONFORMITY

This is an important document and should be retained.

We hereby declare that this product(s) complies with the following directive(s):

2006/42/EC Machinery Directive

The following standards have been applied to the product(s):

EN/ISO 11148-9:2011

The technical documentation required to demonstrate that the product(s) meet(s) the requirement(s) of the aforementioned directive(s) has been compiled and is available for inspection by the relevant enforcement authorities.

The CE mark was first applied in: 2016

Product Description: X-Pro Multi Sender Kit
Model number(s): CAT176
Serial / batch Number: N/A
Date of Issue: 24/05/2022

Signed:

J.A. Clarke
Director

PARTS LIST

No	Description
1	Main Housing
2	Lever Trigger
3	Lever Block
4	Spring
5	Roll Pin
6	Roll Pin
7	O-Ring
8	O-Ring
9	Valve Stem
10	Spring
11	O-Ring
12	Screw Cap
13	Exhaust Muffler
14	Inlet Connector
15	Bearing
16	Rear Plate
17	Bolt
18	Rotor
19	Rotor Blade
20	Cylinder

No	Description
21	Bush
22	Front Plate
23	Steel Ball
24	Bearing
25	Primary Gear
26	Decorating Ring
27	End Fixing Ring
28	End Nut
29	Gear Casing
30	Lubricating Nipple
31	Bearing
32	Secondary Gear
33	Bush
34	Spindle
35	Woodruffe Key
36	Collet
37	Collet Retaining Collar
38	Soft Grip
39	Wrench (small)
40	Wrench (large)

PARTS DIAGRAM

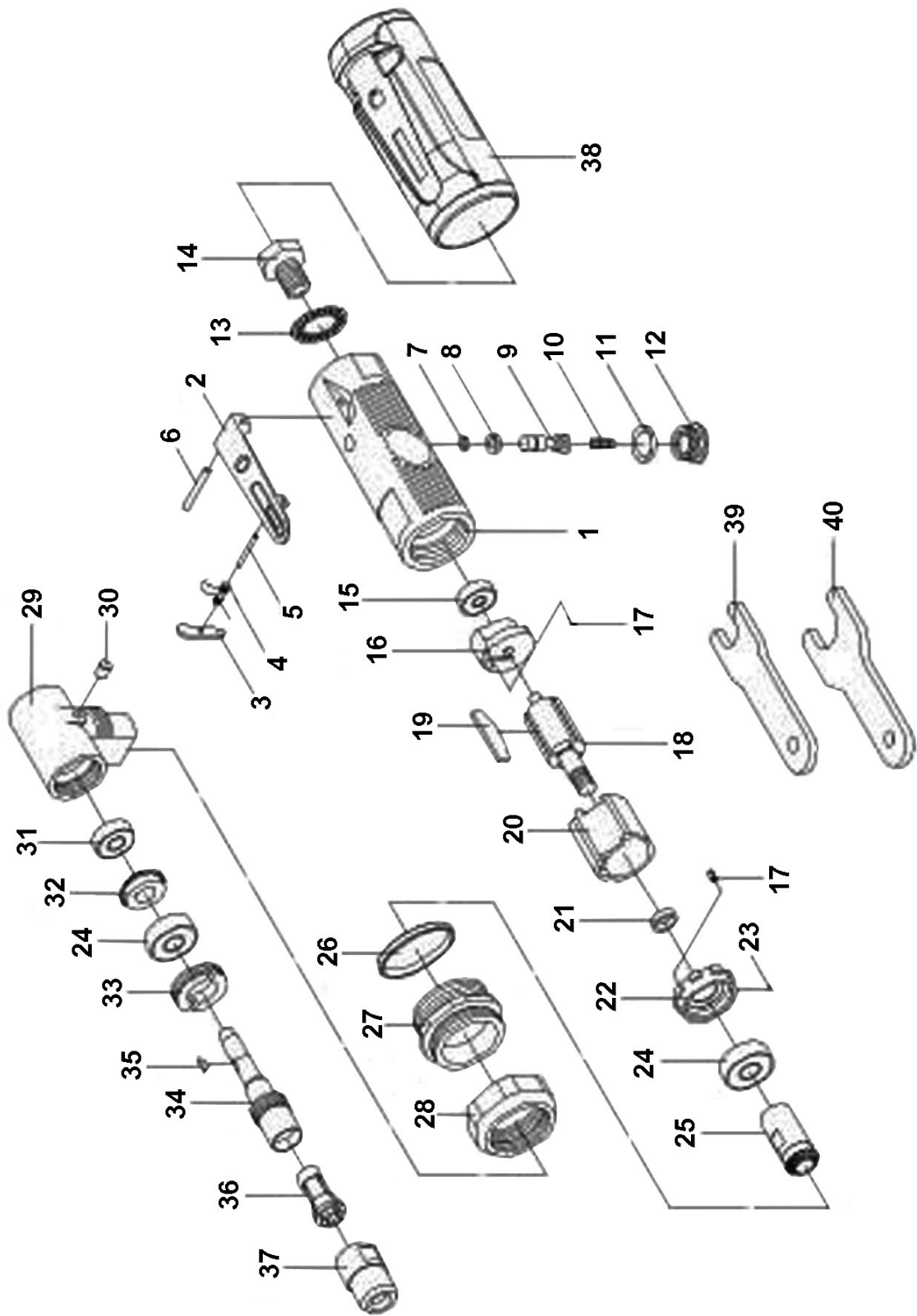

A SELECTION FROM THE VAST RANGE OF

Clarke®

QUALITY PRODUCTS



AIR COMPRESSORS
From DIY to industrial, Plus air tools, spray guns and accessories.

GENERATORS
Prime duty or emergency standby for business, home and leisure.

POWER WASHERS
Hot and cold, electric and engine driven - we have what you need

WELDERS
Mig, Arc, Tig and Spot. From DIY to auto/industrial.

METALWORKING
Drills, grinders and saws for DIY and professional use.

WOODWORKING
Saws, sanders, lathes, mortisers and dust extraction.

HYDRAULICS
Cranes, body repair kits, transmission jacks for all types of workshop use.

WATER PUMPS
Submersible, electric and engine driven for DIY, agriculture and industry.

POWERTOOLS
Angle grinders, cordless drill sets, saws and sanders.

STARTERS/CHARGERS
All sizes for car and commercial use.



PARTS & SERVICE: 0208 988 7400

Parts Enquiries
Parts@clarkeinternational.com

Servicing & Technical Enquiries
Service@clarkeinternational.com

SALES: UK 01992 565333 or Export 00 44 (0)1992 565335

Clarke® INTERNATIONAL Hemnall Street, Epping, Essex CM16 4LG
www.clarkeinternational.com